

Data Sheet



Article number: 201581M1040MTH1

Description: E+G Nut GN 1582-M10-40-MT-H-1
Hygienic design

Measures

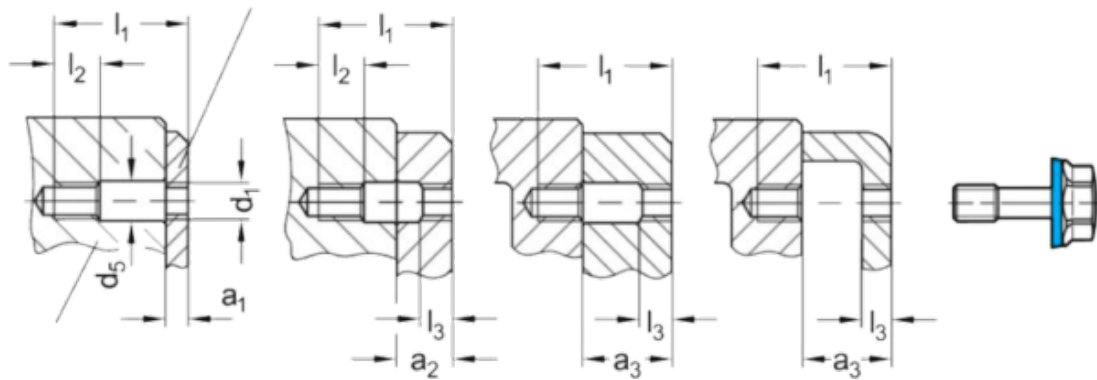
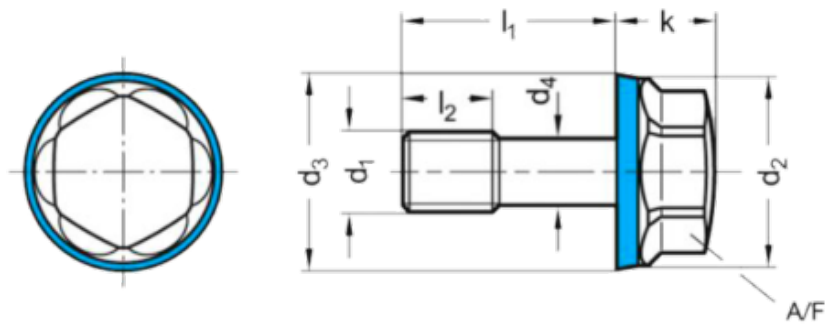

a1	= 5-14	l1	= 40
a2	= 14-19	l2	= 12
a3	= 19-28	l3	= 5
AF	= 16	Weight	= 34
d3	= 19.8		
d4 -0,2 = -			
d5	= 10.5		
k	= 9.5		